

DR416i

Transit Guide



 **WARNING****IGNORING INSTRUCTIONS HAZARD!**

To avoid death or injury you **MUST** read, understand and follow operator's and maintenance manuals before installing, inspecting, operating, servicing, testing, cleaning, transporting, storing, dismantling or disposing of the product or a part or accessory of the product. Keep this publication for future reference.

This page is intentionally left blank

Table of Contents

- 1 Safe Operating Practices - Transit Equipment..... 7**
 - 1.1 Introduction..... 8
 - 1.2 Management’s Responsibilities..... 8
 - 1.3 The Operator’s Responsibilities..... 9
 - 1.4 Operator’s Safety Check.....10
 - 1.5 Planning the Job..... 10
 - 1.6 Operating Precautions..... 11
 - 1.7 General Safety Practices..... 11
 - 1.8 Fire Prevention..... 13

- 2 Lifting Instructions..... 15**
 - 2.1 Lifting and Transporting the Machine..... 16
 - 2.2 Safety First.....16
 - 2.3 Lifting the Machine..... 16
 - 2.3.1 Removing Machine from Transport..... 16
 - 2.3.2 Loading Machine onto Transport..... 17
 - 2.3.3 Shipping Kit..... 18
 - 2.3.4 Lifting the Mast..... 18
 - 2.4 General..... 19

- 3 Truck Driver Instructions..... 21**
 - 3.1 Starting the Machine.....22
 - 3.2 Transportation Mode.....24
 - 3.3 Trimming the Machine..... 25
 - 3.4 Shutting Down the Machine..... 26
 - 3.5 Troubleshooting..... 28
 - 3.6 For Dock Personnel..... 29
 - 3.6.1 Steps for Starting and Operating Rotary Machine..... 29
 - 3.6.2 Technicians Needed for Technical Subjects..... 30



This page is intentionally left blank

1 Safe Operating Practices - Transit Equipment

1.1 Introduction

Sandvik Mining drilling equipment is carefully designed, manufactured, and tested. When operated by trained and qualified personnel, this machine will give safe and reliable service. There are Sandvik Mining offices world-wide to answer questions concerning the safe operation and maintenance of this equipment.

To minimize the risk of accidents and injuries, all persons involved in the operation of this machine must read and understand the following safety precautions.

While we believe that we have properly identified several potential hazards that could result in property damage, injury, or death to personnel, there are certain hazards that may be present that we have not contemplated. It is therefore the responsibility of the machine owner, operator, and crew to be certain that the machine is properly equipped and safe to operate to assure accident-free operation.

1.2 Management's Responsibilities

It is the responsibility of management to:

- See that all operators of this equipment are thoroughly trained (with special emphasis on safety), competent, physically fit, and, if required, licensed.



- Assign specific crew members specific safety responsibilities and instruct them on how to report any unsafe conditions.
- Enforce the use of protective clothing and eye and hearing equipment.



Wear safety footwear



Wear hearing protectors



Wear protective clothing



Wear eye-protector

- See that the operation of this machine is in compliance with all federal, state, and local codes, regulations, and standards.
- Ensure that the work area is appropriately illuminated when operation is performed at night.

- Maintain a complete first-aid kit at the job site. At least two members of the crew or personnel in the area where the machine is operated should be familiar with first aid and cardiac pulmonary resuscitation.
- A thorough inspection of the machine must be performed before putting into service and scheduled maintenance must be followed during its life. Due to stress of operation can vary by site and use, periodic examination of frames, masts, ladders, and all welded items should be done to ensure structural integrity is maintained.

1.3 The Operator's Responsibilities

Safety must always be the operator's most important concern. The operator must refuse to operate the machine if an unsafe condition exists. It is the responsibility of the machine operator to ensure that the machine is properly equipped, safe to operate, and that the site conditions make it possible for safe operation.

- The operator must see that all emergency stops, "operational aids" and "warning signals" are functional before operating.
- The operator must be alert, physically fit, and free from the influences of drugs, alcohol, and medications that might impair eyesight, hearing, or reactions.
- The operator should not attempt to start or operate the machine unless he has been properly trained and reads this manual.



- Report transit damage to the appropriate authorities.
- Do not operate equipment that has visual signs of component or structural damage.
- The operator should not operate this equipment if any of its controls display a "lockout" tag.
- If an unsafe condition exists, the operator must place a tag, identifying this condition, on the starting controls and alert other potential users of the machine.



- The operator should not operate the machine without first checking that all personnel protection devices and machinery guards are in place.



1.4 Operator's Safety Check

The operator must make a safety check before starting to work to ensure that the machine is in proper order for accident-free operation. Some things to check are:

- Check that there are no "lockouts" or "tagouts" attached to the controls.



- Ensure fluid levels are correct per the operator's manual and no leaks present prior to starting.
- After starting the engine, check all indicators, emergency stops, trip devices, and gauges for serviceability.
- Check the fire extinguisher(s) for charge and accessibility.
- Clean the cab interior windows if necessary.
- Check access ladders and decking for damage and slipping hazards such as mud, oil, or ice.



- The operator must properly secure the machine to prevent the machine from being operated by unauthorized individuals.
- The operator must never permit personnel to ride on the machine except in the passenger compartment.
- The operator should treat all power lines as live.



1.5 Planning the Job

The person in charge must have a clear understanding of the work to be done and consider all the hazards at the site. He must develop a plan to do the job safely and explain the plan to the crew members involved. Factors such as these should be considered:

- Are there utility lines or structures that must be moved or avoided?
- Are there unusual or extreme weather conditions expected?
- Will moving the machine be done in a confined space?
- Will operating the machine be done in night hours?
- Will the machine be propelled on inclines?
- Will special transport tools be required to complete the job?

1.6 Operating Precautions

- Operating near or contacting a power line with any part of the machine can result in electrocution.

Use extreme caution when operating machines in the vicinity of electrical power lines. Check the minimum safe operating perimeter set by local, state or federal regulations when equipment is near power lines.



- Before leaving the operator's station, all controls must be in the neutral position with all locking and safety devices engaged.

Do not allow the machine to operate unattended.

- Do not park or position the machine on grades that exceed the tilt ratings.

Park or position the machine on level ground or across (horizontal) grade.

- Park or position the machine to allow the wind to carry engine exhaust fumes away from the operator.

Exhaust fumes from diesel engines are lethal.

- Accessories and decks may be attached to the mast for transit purposes.

Do not operate the mast function with accessories secured in the mast for transit.

1.7 General Safety Practices

While operating this machine, be aware of the following:

- The sudden release of a pressurized lid or hose can spray hot oil.

Do not open hydraulic tanks, air reservoirs, or hydraulic connections while the machine is running or the systems are under pressure.

- Pressure in hydraulic systems can be retained for long periods of time. If not properly released before maintenance people attempt to work on the hydraulic system, this pressure can let components move or cause hot oil to spray and hose ends to shoot out at high speed.

Release the system pressure before attempting to make adjustments or repairs.



- Before entering any enclosure, be sure that the door is securely open. To avoid entrapment, be sure that no one is inside any enclosure before closing and latching the doors.

Enclosures can cause suffocation.

- Before starting any service or maintenance work, always perform a safety/risk analysis of the task.

Performing maintenance work without the proper tools and personal protection equipment can cause serious injury or death.

- Climbing the mast is a crushing and falling hazard.

Climbing the mast may cause serious injury or death. Stay off the mast at all times.

- Hydraulic oil, under extreme pressure from a small opening, can penetrate the skin and inject oil into the body.

Do not attempt to locate a hydraulic leak by using your hand.



- Carelessness in getting on and off equipment can result in serious injuries.

Always wait until the machine has completely stopped. Do not jump on or off. Always use both hands and feet, and use the 3-point contact rule.



- Riding the rotary head up and down the mast is a crushing hazard.

Never ride the rotary head for any reason!!! It was not designed to be an elevator.

When there is a need for an operator or helper to work on the rig in the working area or danger zone and this work involves activation of one or

several machine functions, this work shall only be done under the following conditions:

1. There must be two safety-trained people present; one should supervise the safety of the other doing the servicing. Supervision should be done from the operator's station to ensure immediate access to an emergency stop at all times.
2. The area where the operation is to be done should be properly illuminated.
3. A reliable mode of communication should be established between the operator and the supervisor.
4. The rig must be completely shut down and all methods of starting disabled before servicing work begins.

1.8 Fire Prevention

- Clean-up any oil and fuel spills, particularly around hot surfaces and heat-producing components.



- Check the Fire Suppression System (FSS), if fitted, for damaged hoses or cylinders.
- Check all electrical lines and connections including battery terminals for a tight fit, wear, abrasion, and corrosion.
- Check all machine ignition points (engine block, exhaust manifolds, mufflers, turbochargers, etc.) to make sure they are not in contact with any hoses.
- Keep the batteries secured in their compartment and covered.
- Never inject ether or other starting aids into the engine and compressor intake filter(s). Ether or other aids drawn into the compressor can cause an explosion.



- Do not store flammable fluids on or in the immediate vicinity of the machine.
- Engine oil, hydraulic fluid, and compressor oil are flammable. Do not operate a machine with leaking hoses or lines.

- Do not attempt to perform welding repairs until all flammable materials, including oil and fuel spills oily rags, and rock and coal dust, have been isolated or removed from the machine.



- Disconnect the battery cables before welding on the machine.
- Keep tools away from exposed live electrical parts, such as terminals, to avoid arcing.
- If charging the batteries, always turn the charger off before making or breaking connections to the battery.

2 Lifting Instructions



2.1 Lifting and Transporting the Machine

The following procedures are to be used as a guide. The equipment you have and the regulations for lifting and transporting this type of equipment will vary.

1. Clean the machine to remove any rocks or dirt that might dislodge during transporting.
2. Before lifting the machine, refer to the technical data plate to determine the machine's weight (GVW). Lifting points (4 places) are marked on the machine.

2.2 Safety First

- Always perform Job Risk Assessment.
- Always wear proper PPE.

2.3 Lifting the Machine

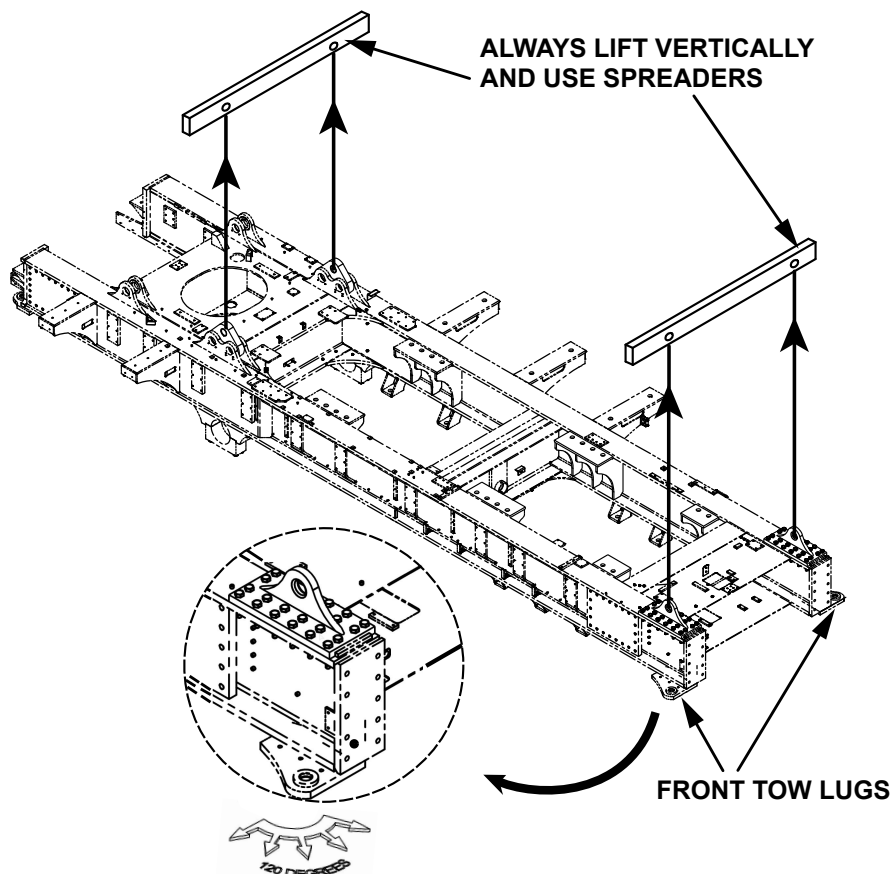

All the lifts should be vertical and spreaders must be used to prevent side loads on frames or masts.

2.3.1 Removing Machine from Transport

Prepare the loading area for the machine before loading operations begin.

1. Position the cranes to lift the machine.
2. Position the truck with the machine underneath the cranes, allowing room to pull the truck from under the machine once it is lifted.
3. Ensure the shipping kit is installed on the machine.
4. Connect the cranes and lifting devices to the machine. The lifting device should hang from crane hooks.
5. Attach the lifting devices to the lift points on the machine.
 - Front lift lugs (2) (near front tow points)
 - Pedestal lift lugs (1).
6. Use spreaders to keep a vertical load on all lifts.
7. Lift the machine from the truck.
8. Position the machine over the ship.
9. Lower the machine onto the ship.
10. Use wood blocking to stabilize the machine on the ship and to keep weight off the fuel tank.
11. Secure the machine on the ship.

All the different situational requirements cannot be given, so always consult your dealer if questions arise regarding lifting or towing this machine.



2.3.2 Loading Machine onto Transport

Prepare the loading area for the machine before loading operations begin.

1. Position the cranes to lift the machine from the ship.
2. Connect the cranes and lifting device to the machine. The lifting device should hang from crane hooks.
3. Attach the lifting devices to the lift points on the machine.
 - Front lift lugs
 - Pedestal lift lugs.
4. Use spreaders to keep a vertical load on all lifts.

5. Drive the transport vehicle underneath. The transport should be backed under the machine to keep the vehicle operate away from the area directly under the machine.
6. Lower the machine onto the trailer.
7. Use wood blocking to stabilize the machine on the trailer and to keep weight off the fuel tank.
8. Secure the machine on the trailer.

All the different situational requirements cannot be given, so always consult your dealer if questions arise regarding lifting or towing this machine.

2.3.3 Shipping Kit

Ensure the shipping kit is installed and secured to the machine. If not, install a shipping kit before transporting the machine.



1. Install the shipping brackets.
2. Cut the old remains away if necessary.
3. Use a forklift or other lifting device to hold brackets in place.
4. Weld new shipping brackets in place.
5. One bracket attaches to the frame near the front of the crawler.
6. One bracket attaches to the axle.

2.3.4 Lifting the Mast

Lift the mast only at the lift locations indicated on the mast by lifting decals. Any other lifting points could damage the mast.

Note: Perform a risk assessment with the assembly crew and crane operator prior to lifting the mast structure. Establish crane operators and ground guides that will communicate during the lift and install process.

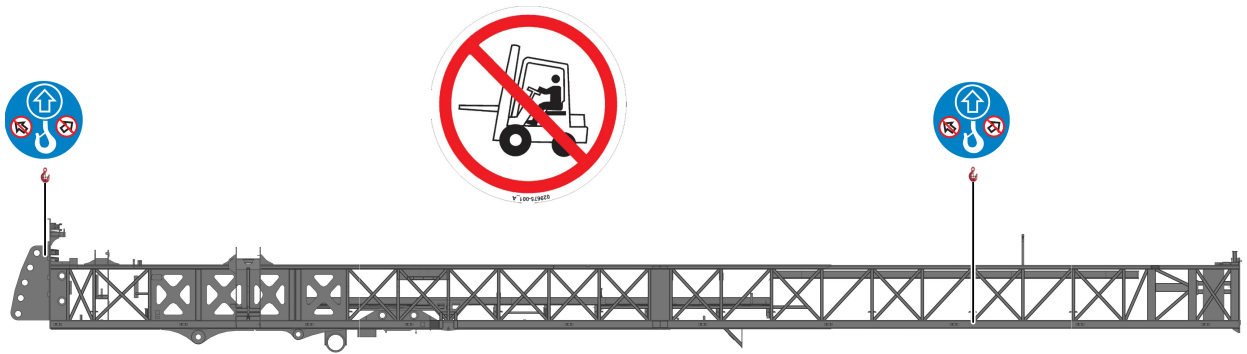

2.4 General

The intended purpose of this manual is to assist truck drivers and shipping dock personnel with starting and moving Sandvik rotary drilling machines.

1. The procedures listed herein can be used as a guide to operate or troubleshoot starting or operating a Sandvik rotary drilling machine.
2. The procedures listed have been recorded start or operational problems and symptoms that may limit machine start or machine operation.
3. When required, machine-specific procedures will be noted.
4. Check and/or correct the item or items noted.

Attention Truck Driver and/or Dock Personnel:

If you have trouble starting or operating this machine and you alter this product in any form, please make notice inside the cabin of the discrepancy for our recipients at their final destination. Someone at the final destination must make the necessary troubleshooting repairs. Altering this product for the purpose of transport may affect the product warranty.

Sandvik Mining and Construction

Alachua, Florida USA

386-462-4100 Product Support

After hours contact:

David Gillenwalters 352-213-3069

Prior to calling, please note the machine model by the decal on the frame and the 6-digit numeric serial number (73xxxx) inside the cabin on the door. These two items are required so we can better assist with starting or operational problems:

Machine Model

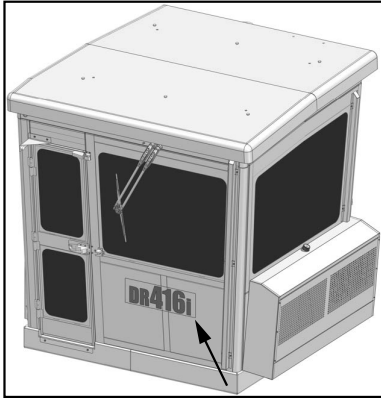

Machine Serial Number 6 Digit #

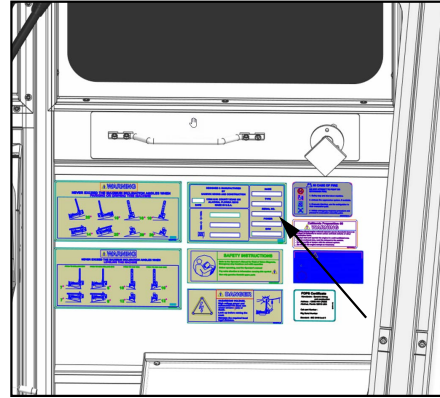



3 Truck Driver Instructions

3.1 Starting the Machine

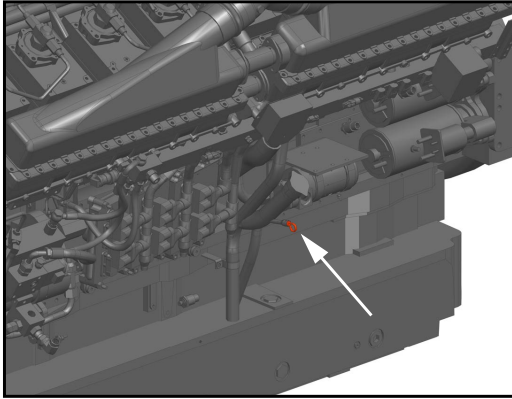
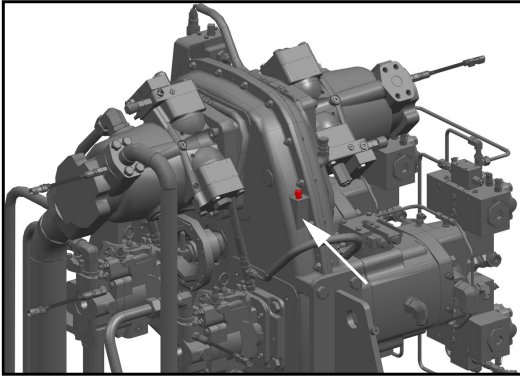
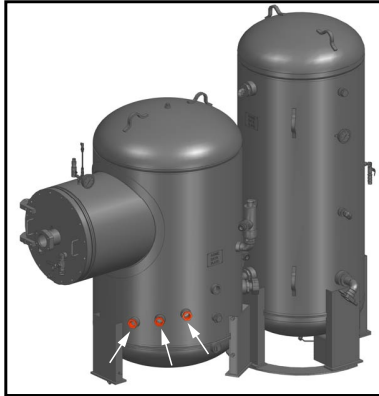
Use the following table as a tool for starting the machine.

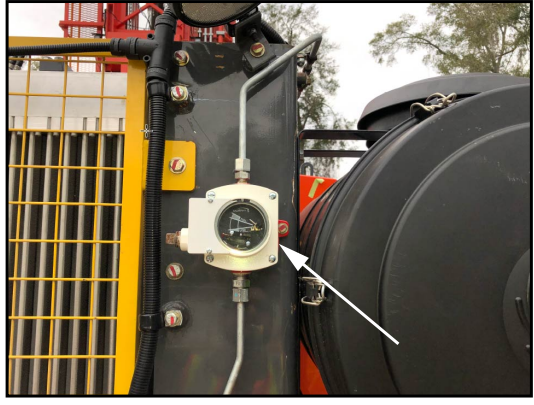
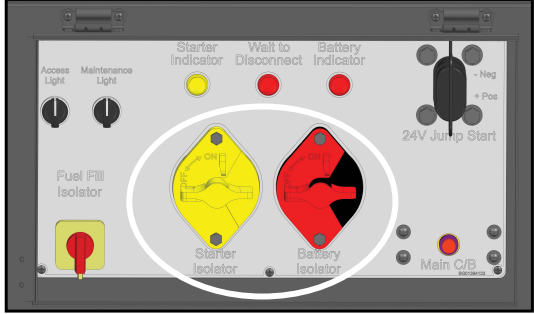
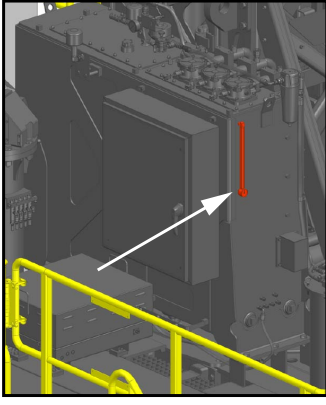
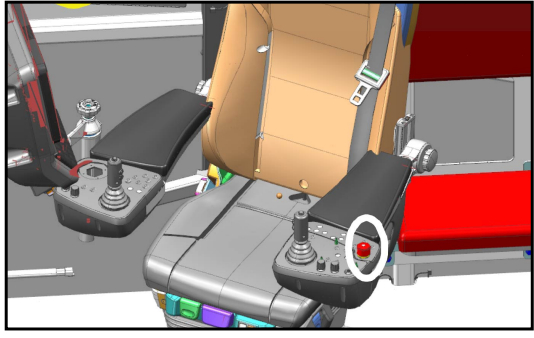
Function	Location
1. Check fluid levels.	
Engine oil (dipstick)	
Gearbox oil (dipstick)	
Compressor oil (center sight glass)	

Function	Location
Radiator coolant (sight glass)	
2. Set Starter Isolator and Battery Isolator to ON.	
Check hydraulic level.	
3. Operator controls in neutral position.	
Do not push joysticks.	
4. Ensure that E-Stop (red button) is not depressed.	

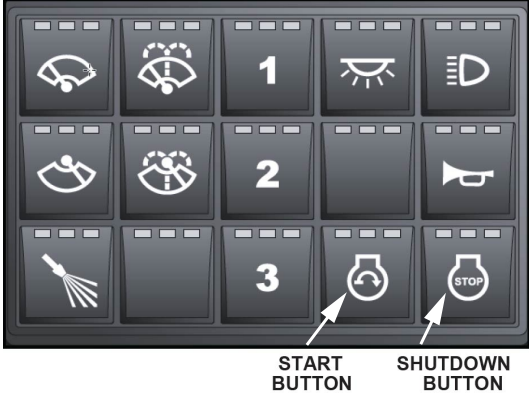
Function	Location
<p>5. Ensure the control panel lock-out switch is in the ON position.</p>	
<p>6. Key switch 'ON' and wait for the display to power up prior to pressing 'START BUTTON'.</p>	
<p>7. Push the Start button.</p> <p>Note: Some machines use an engine pre-lubrication system, which is activated by the START button. This function causes a slight delay before the engine begins to crank and is normal.</p> <p>Note: If the engine fails to start or stay running, wait for receiver air pressure to drain to zero before attempting to restart.</p>	

3.2 Transportation Mode

The machine is shipped from the factory with the transportation mode turned ON. In this mode, the bypasses are set to ON automatically and machine is ready for tramming.

When transportation mode is activated, home screen appears dim. Refer the image below.

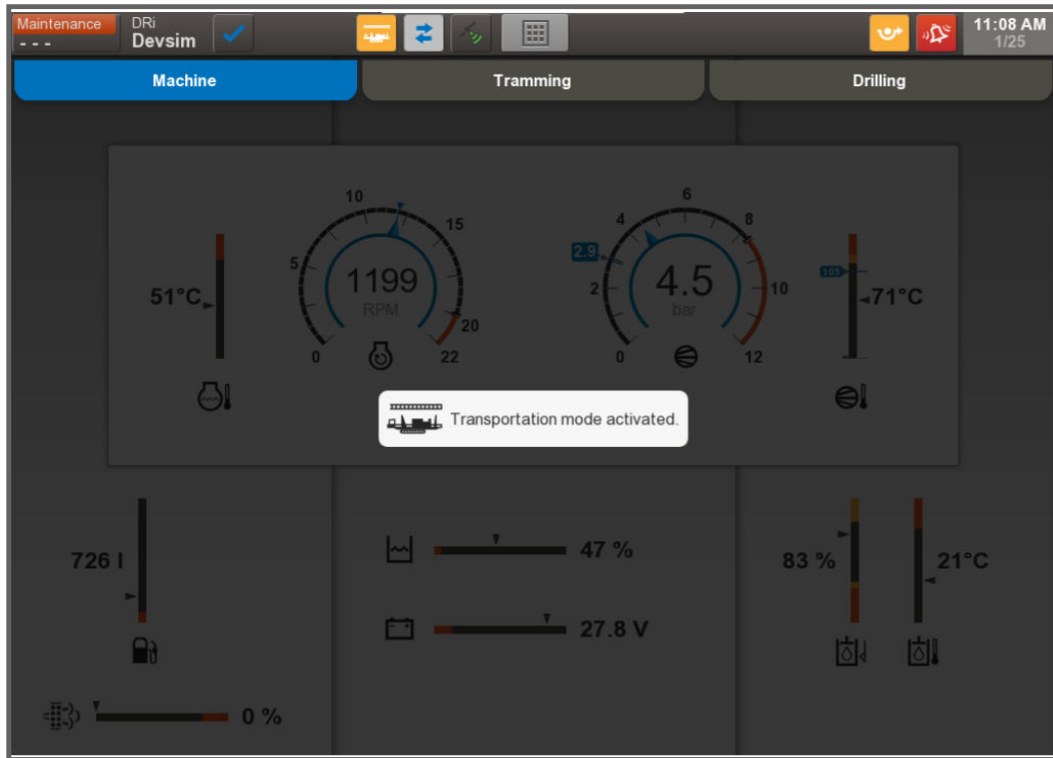

3.3 Tramming the Machine

Use the following table as a tool for tramming the machine.

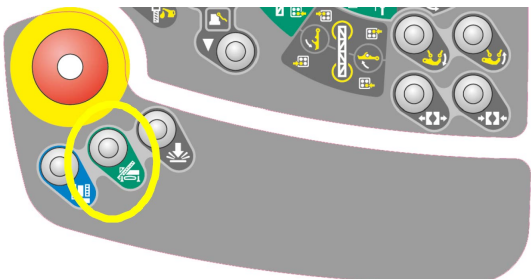
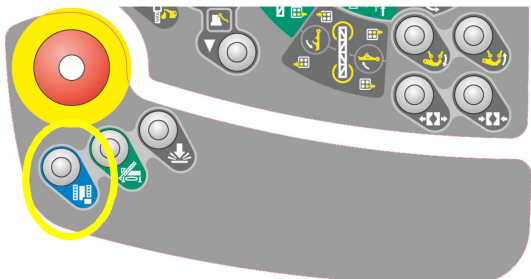

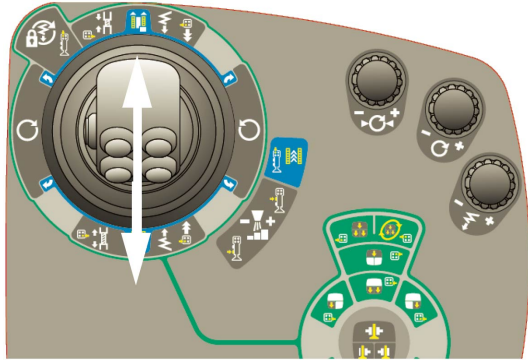
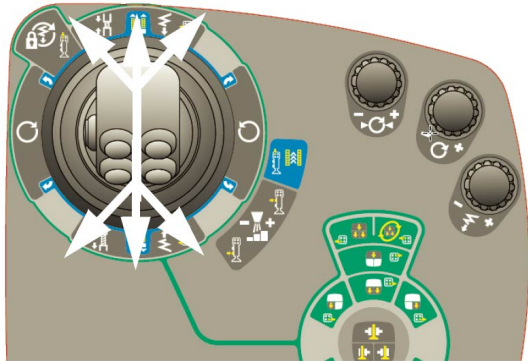
Function	Location
<p>1. Ensure the jacks are fully up before tramming. If not, press the Setup button (green) and raise the jacks before attempting to tram.</p>	
<p>2. Press the Tram Mode button (Blue button on Left Control Panel) to engage Tram Mode, and use joystick on the Right Control Panel to move in the desired direction.</p> <p>Note: If the machine will not tram or show any error messages, refer to the Troubleshooting (Page 28) section.</p>	

Function	Location
<p>3. Use the Right joystick on the right armrest to tram the machine.</p> <p>4. Push forward to tram forward on that same side. Pull rearward to tram rearward.</p> <p>Note: The coolers are at the FRONT of the machine. The cab is at the REAR of the machine.</p>	
<p>5. To turn the machine, use the Right joystick.</p> <p>6. Push the joystick forward, and then push in the direction to turn. Pull the joystick rearward and then push in the direction to turn.</p> <p>Note: The joystick must be forward or rearward. Only pushing left or right will not turn the machine.</p>	



3.4 Shutting Down the Machine

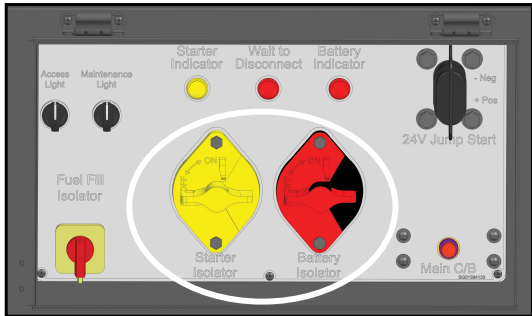

Use the following table as a tool for shutting down the machine.

Function	Location
<p>1. Operator controls in neutral position.</p> <ul style="list-style-type: none"> • Do not push joysticks. • Do not press E-Stop (red button). 	

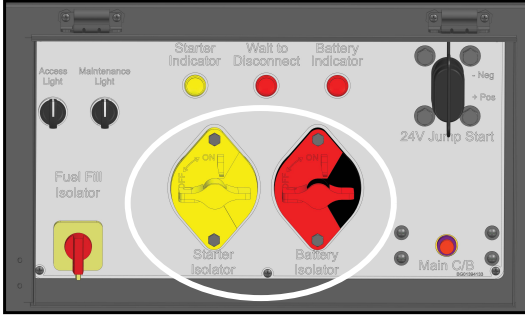
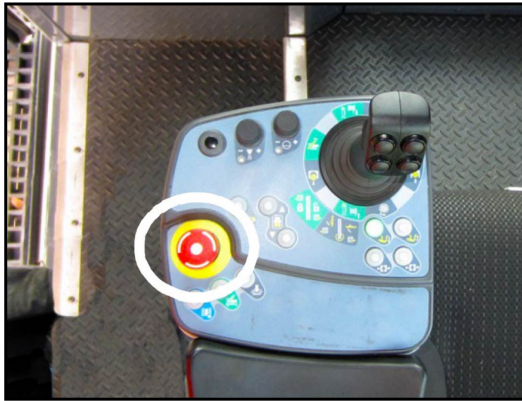
Function	Location
<p>2. Actuate the Shutdown button.</p> <p>3. Press and release the "Shutdown Button". Wait until the engine has shut down.</p>	 <p style="text-align: center;">START BUTTON SHUTDOWN BUTTON</p>
<p>4. Key switch to 'OFF'.</p> <p>5. Wait for the control screen to shut down (the display will turn dark or black). Note: The control screen will not shut down until the key switch is turned OFF.</p>	 <p style="text-align: center;">KEY SWITCH</p>
<p>6. Set the Starter Isolator and Battery Isolator to OFF. Note: Wait for the green light (Wait to Disconnect) to go off before switching the isolator switches to the off position.</p>	

3.5 Troubleshooting

Problem	Items to Check/Correct	Location
<p>1. The engine will not start.</p> <p>Note: There is no power in the cab (Control screen does not come on.)</p>	<p>Battery isolator switches.</p>	
<p>2. The engine will not start.</p> <p>Any of up to four emergency stop push buttons interrupts starting.</p>	<p>Emergency stop push button 1 on the cab operator panel.</p> <p>On the operator's Left Control Panel, turn the red button counterclockwise to release.</p> <p>Emergency stop push button 2 beside the boarding ladder. This switch may be removed from the frame and tied for transit. Turn the red button counterclockwise to release.</p>	 

Problem	Items to Check/Correct	Location
	<p>Emergency stop push button 3 is located on the Main Electrical Cabinet (MEC). Turn the red button counterclockwise to release.</p>	
<p>3. The engine will not start.</p>	<p>Main circuit breaker on the engine junction box Push to reset the main breaker stamped with 105 or 175.</p>	

3.6 For Dock Personnel

3.6.1 Steps for Starting and Operating Rotary Machine

Refer to the truck driver instructions for starting and operating.

Use the following table as a tool for troubleshooting the machine. This section notes technical details that may require hand tools to troubleshoot and get machines operating.

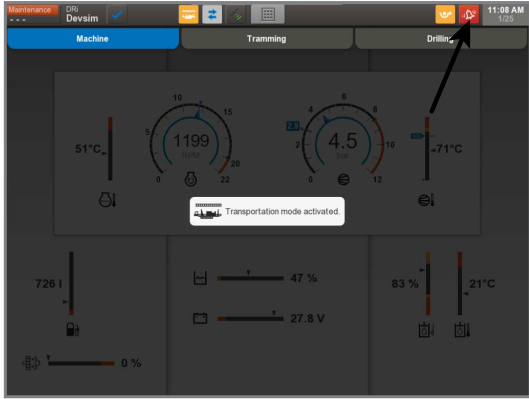
Problem	Items to Check/Correct	Location
<p>1. The engine will not start. The engine turns over, spinning fast. There is no evidence of fuel. No start condition.</p>	<p>Power when the key is engaged. Check the fuel level. After engaging Start, the machine will continue to try starting until E-Stop is pressed.</p>	<p>Reference emergency stop switches. Reference fire suppression switch. On the left armrest.</p>
<p>2. The engine will not start. The engine turns over, spinning fast. No start condition.</p>	<p>Check the alarm log by pressing the red bell icon (top right of the display screen) for active alarms. Engine problem requires a technician. Call the factory with the machine model and serial number.</p>	

3.6.2 Technicians Needed for Technical Subjects

The following may require hand tools and technical support.

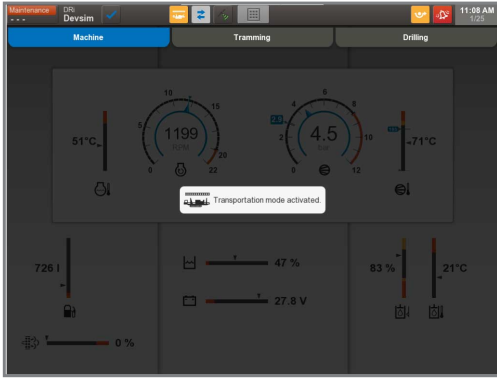
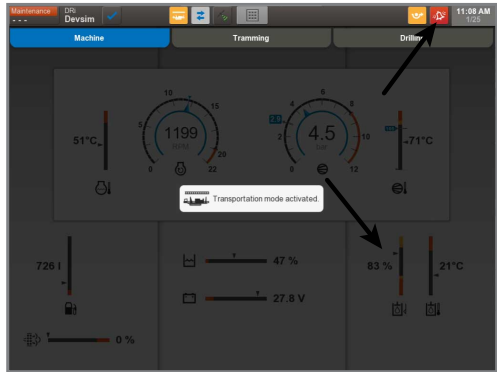
Problem	Items to Check/Correct	Location
<p>1. The engine starts, and the engine stops. The engine starts, then stops. No start condition.</p>	<p>Low air pressure in the air receiver tank.</p> <p>Check air hoses, inlet control valve, or call the factory with the machine model and serial number.</p>	<p>After system starts, air pressure will rise to 8.5 bar.</p> <p>Note: The gauge should not exceed the red range.</p> <p>If air pressure is in the red, the tank is over-pressurizing and an alarm will notify the operator of exceeding pressure within the receiver tank.</p> <p>If receiver tank pressure is below 2 bars, the system will shut down and an alarm will activate, notifying the operator of low pressure.</p> <p>Note: A low compressor oil pressure alarm will be activated.</p> 
<p>2. The engine starts, and the engine stops. The engine starts then stops. No start condition.</p>	<p>Check fluid levels.</p> <p>Turn the ignition key OFF and allow the GUI to shut down. Turn the ignition key ON, allow the GUI to reboot, and restart.</p>	

This page is intentionally left blank



www.sandvik.com