

DS412iE Electric rock bolter

Technical Specification





Ergonomic and comfortable cabin

Electric tramming

Make the change

Sandvik DS412iE is a highly automated, productive battery powered bolter for underground mining operations and civil construction tunneling.

The bolter is equipped with an electric driveline system including a battery package and electric motor for zero emissions while tramming. Sandvik DS412iE avoids spreading emissions into the environment, reduces thermal load and thus requirements for ventilation capacity underground.

The i-Class platform offers various levels of automation for rock support drilling as well as a large component commonality through the 400i drill range.

This highly instrumented equipment ensures comprehensive data collection through the entire bolting process for better rock supporting quality in drifts and tunnels.

Key features

Optimum bolting coverage	4.5 m x 4.5 m
Bolt length	From 1.5 m to 3.0 m (5' to 10')
Turning width (T-section)	4 200 mm
Onboard battery package	Sodium-Nickel-Cloridetechnology
Max. battery energy	100 kWh
Tramming distances	18 km (flat ground), 3 km (1:7 incline upwards)
Transport width	2 500 mm
Transport / drilling height	3 050 mm / 3 315 mm
Transport length	13 100 mm
Total weight	30 000 kg depending on options

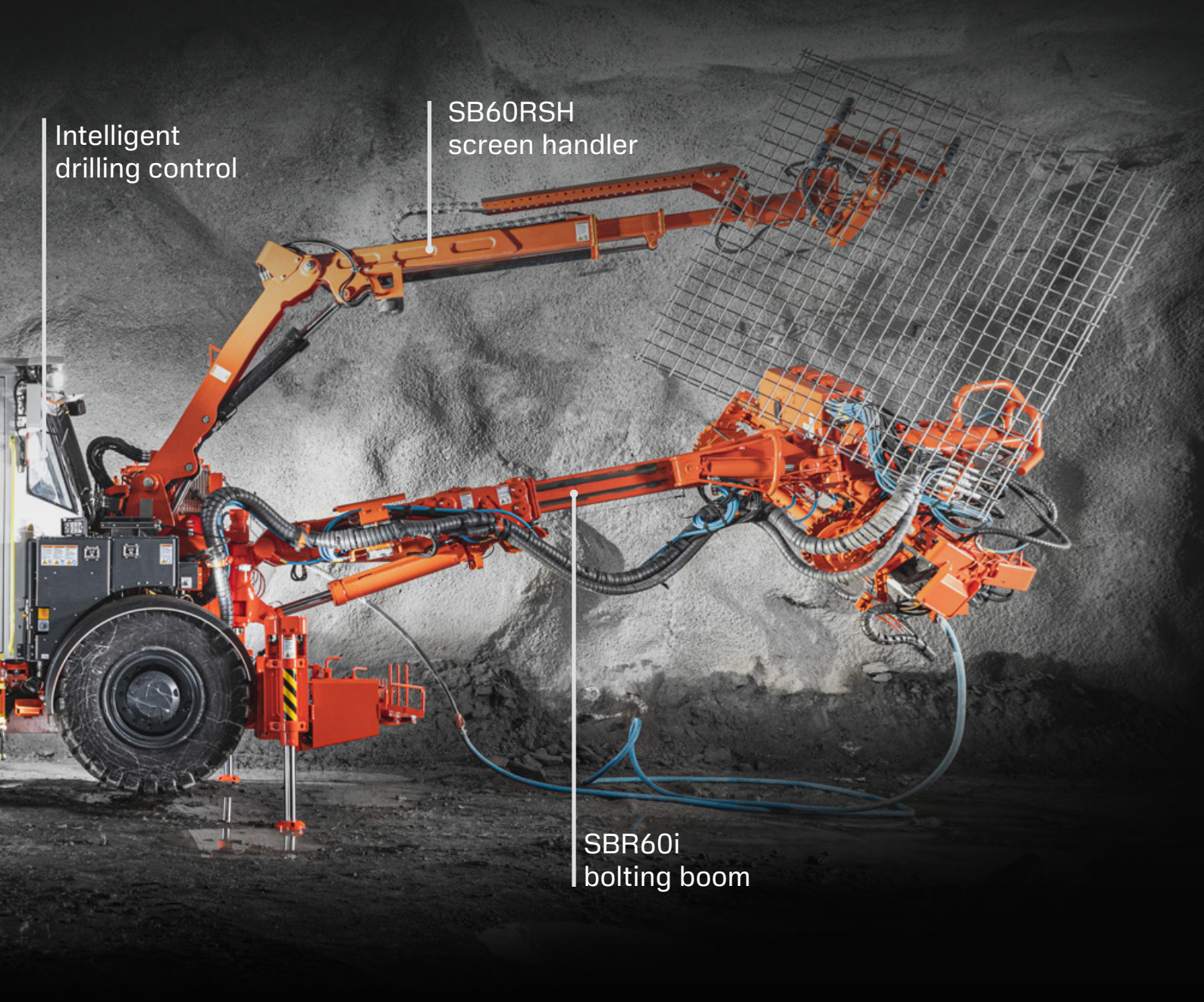

Intelligent
drilling control

SB60RSH
screen handler

SBR60i
bolting boom

Main benefits

Fast and automated one bolt automation

Sandvik DS412iE is a bolter for 4 x 4 meters size headings combining a safe, ergonomic working environment with high levels of automation.

Equipped with a completely new carrier, a high frequency rock drill, an intelligent control system and an ergonomic cabin, the DS412iE offers high levels of safety and efficiency providing peace of mind for all rock reinforcement operations.

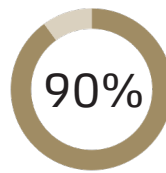

**Better
efficient**

Up to 90%*
automatic bolt
installation

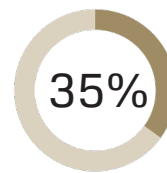

**Improved
productivity**

Up to 35%*
higher penetration
rate

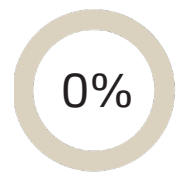

**Safer working
conditions**

0%* diesel
emissions while
travelling



Upgraded BHI bolting head

With different bolt lengths, it enables wider bolt selection for all customers. Automatic resin shooting and cement mixing system ensure high quality rock reinforcement process.

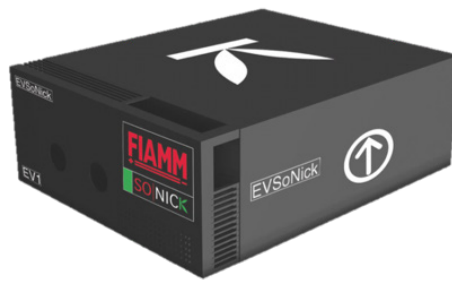

100 kWh Onboard batteries

Sandvik DS412iE is equipped with onboard battery package for an tramming. With it's four batteries onboard, the power available is 100 kWh and allows to tram distance up to 18 km.



Intelligent power management system

The charging of the batteries can be done during normal drilling cycle to ensure maximum tramming energy availability at any time. If needed, energy from batteries can also be used for drilling, offering additional freedom.



Digital Driller™

Through simulation, operators develop skills fully from basic boom movements and manual drilling to full automated drilling operations using various training scenarios.

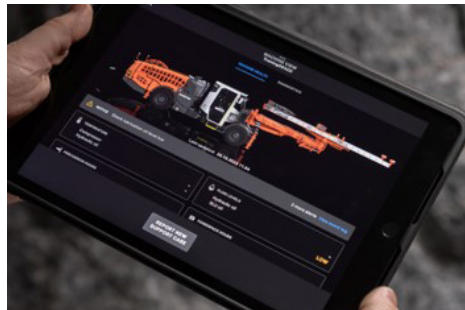

Sandvik DrillConnect

Readiness for Sandvik DrillConnect mobile application for improved data management and enhanced maintenance, and My Sandvik digital services.



SB60RSH Screen handler upgraded

With its new gripper, the SB60RSH is the perfect tool for the mechanization of wire mesh installation along hanging walls, back walls, and/or side walls.



Sandvik 365 Parts and Services

Proudly keeping you on track!

Sandvik 365 Parts & Services offer a variety of possibilities to enhance your Sandvik DS412iE drill's performance. As an OEM, we provide the best-suited choices to preserve your machine's high performance throughout its lifetime.

These consist of highly skilled service specialists supporting you 365 days a year, all using Sandvik Genuine parts and components complemented by a range of robust tools.

In addition, you get to enjoy the benefits of advanced digital services and a global infrastructure dedicated to keeping your Sandvik fleet on track.

Technical Specification

Hydraulic rock drill

Type of rock drill	RD314 (TS2-137)
Percussion power	14 kW
Percussion pressure	Max. 160 bar
Percussion rate	110 Hz
Rotation speed	Max. 520 rpm (with OMS100)
Rotation torque	340 Nm (with OMS100)
Hole size (bolting)	33 - 43 mm
Shank adapter	45 mm / R32 female
Weight	122 kg
Length	571 mm

Bolting head

Type of bolting head	BHi (TS2-277)
Bolting head feed	KS140
Bolt carousel capacity	8 rock bolts with 200 x 200 mm maximum plate size
Bolt head length	Max. 4 342 mm (BH30)
Net weight	Max. 1 720 kg (BH30)

Bolting boom

Type of boom	SBR60i (TS2-478)
Boom extension	1 200 mm
Boom weight, net	2 200 kg
Roll-over angle	358°

Hydraulic system

Powerpack	HPP1590 (90 kW)
Filtration size (pressure / return)	20 µ / 10 µ
Oil tank volume	270 liters
Cooler for hydraulic oil	OW45 oil-to-water (45 kW)
Low oil level indication	Low oil level switch

Drilling control system

Control system type	SICA
Drilling control modes	Intelligent Torque control / Feed percussion / manual
Upgradeable automation levels	
Comprehensive diagnostic system	
Electronic joystick controls	
15" full color touch screen	
Cable kit for spare part programming	
Safety lock for movement prevention	2 switches
MySandvik insight / OptiMine / WLAN	Data transfer readiness

Automation package, Silver level (Standard)

Drilling control system	Torque or manual drilling
One-bolt automation	Drills one hole automatically
Boom manipulator mode	Operator can lock XYZ-axis
Hole angle measurement	Boom tilt and bolting module rotation indication
Drill bit navigation	Drill bit can be used for bolter navigation
Basic remote data monitoring	Info about drilled meters installed bolts
Automatic cement mixer	Mixing one batch automatically

Electric system

Multivoltage	Compliance from 380 to 1 000 V, 50 and 60 Hz
Total installed power	205 kW
Main switch gear	MSE 10
IP-classification	Specification TS2-132
Starting method	Inverter controlled soft starting Typical inrush current peak less than 1 kA (duration less than 20ms)
Automatic cable reel	TCR4CE with spooling system
Cable reel control	Operator station and remote control at rear machine
Front lights	6 x 50 W LED (24V) >125lx, 20 000 lm; 6 000 k
Rear lights	2 x 50 W LED (24V) and 2 x 17 W LED (24V) 8 000 lm; 6 000 k
Remoted search light	1 x 50 W LED (24V)
Outlets on carrier	1 x 110 V or 230 V (16A)
Parking rear brake / park lights	2 x Red LED
Stair and service lights	LED (24V)
Amber flashing light	LED (24 V)
Electric quality monitoring	Voltage, Amperage, Power, Pf Energy, Phase-sequence
Onboard battery package	Sodium-Nickel-Chloride technology, 100 kWh max. energy
Intelligent power management system	Battery charging during drilling, Presetable power compensation available from the batteries during peak loads in drilling
Protection	MSE IP66/Nema4x, junction boxes ≥ IP68

Air and water flushing system

Flushing of holes	By Water
Water booster pump type	WBP1
Water pump capacity	50 l/min
Water pump inlet pressure	2 bar (Min.)
Flushing water pressure	10 - 15 bar
Shank lubrication device	SLU-1 (Air / oil mist)
Air compressor	CTN10 (1.0 m³/min at 7 bar)
Oil consumption	150 - 250 g/h
Air consumption	250 - 350 l/min

Operator's safety cabin

Cabin certification	FOPS / ROPS (ISO 3449)
Operation	Seated tramming Standing and seated drilling
Sound pressure level	According to EN 16228, ISO4872, ISO1120. Operator station: 69 db(A)
Vibration level	According to EN791/ISO2631-1
Operator's seat	Fully adjustable seat (tramming and drilling)
Optimized dust level control via air circulation	
Air conditioning system	EU6/7 filtering capacity
Cabin heating	During tramming and drilling
Electricity outlets	1 x 24 V, 1 x 12 V
Stairs and indoors lights	LED
Audio player	CD / MP3 player with radio
Boot washer	At each cabin entrance
Safety laminated acoustic windows	

Technical Specification

Carrier

Type of carrier	C400E (frame-steered)
Carrier articulation	± 40°
Rear axle oscillation	± 8°
Ground clearance	330 mm
Transmission	Inverter controlled electric motor with mechanical link to axles
Axles	Dana Spicer
Tires	14.00–24 PR28
Brakes	SAHR type, fail-safe wet disc brakes
Tramming speed	10 km/h (flat ground) 5 km/h (from 0 to 1.5 km) and 3 km/h (from 1.5 to 3 km) in 1:7 incline
Tramming distances	18 km (flat ground), 3 km (1:7 incline upwards)
Gradeability / sideways tilt	Max.15° / 5° (according to EN 16228-2)
Hydraulic jacks	2 x SJ500 (front) 2 x SJ600 (rear)
Brake release	Manual hand pump
Wheel chocks and holders	2 Sets
Centralized greasing points	Specification TS2-463
Hand held fire extinguisher	1 x 7.7 or 9 kg (type ABC)
Tramming cameras	Rear and side
Tramming alarm	Standard
Toolboxes and first aid kit	
Knowledge Box™	Connectivity solution (TS2-535)
Colour scheme	Sandvik
Documentation	1 x Operator's manual 1 x Maintenance manual 1 x Technical manual (in English only) 1 x Parts manual (in English only) 2 x Toolman USB key

Automation package, Gold level (option) - TS2-539

Automation Silver package content	
Bolt plan transfer	
Bolting according to plan	
Near hole automation	
Total station navigation	
MWD capability	
Full remote data monitoring	
DrillConnect mobile application : Connectivity through Knowledge box™ for easy data transfer to and from the rig	

Automation package, Platinum level (option) - TS2-539

Automation Gold package content	
Position route drawing: Bolt plans adjusted to actual profile according to recorded position route	
Full fan automation: Automatic boom movements from one bolt location to next one	

Optional features and packages

Bolting head	
*Bolt carousel capacity	10 rock bolts for square plate 200 mm 12 rock bolts for square plate 150 mm
Bolting option	
*Bolting alternatives	GCR with automatic resin system (ARI), BCS with automatic cement mixer, GBR Bulk resin system, WI water inflated, S Splitset bolts, M Mechanical bolts Specification TS2-290
"In the hole" resin cartridges injection system	
Screen handler	SB60RSH separate boom (TS2-324)
Bolt storage and bits rack	On right side, or front module
Bolting head oiler	Recommended with BCS-system
Hydraulic system	
Vacuum pump	For hydraulic system
By pass oil filter	
Drilling control system	
Boom movement prevention switches	Indicator lights
Access detector, or protector	Mandatory in Europe (TS2-211)
Cleaning system	
HP system with reel	Up to 180 bar (TS2-343)
Bolting module continuous washing system	Remote controlled
Greasing systems	
Automatic system	Lincoln (complete)
Manual system	Pump reel and nozzle (TS2-463)
Electric system	
*Electric cables	Specification TS2-121
Dewatering pump outlet	8 kW, Site voltage 380 - 690 V 8 kW, Site voltage 1 000 V 400V (16A) with transformer
Indicator lights for jacks	Up and down
Earth continuity control	1 wire pilot circuit with remote reset / disconnect
Battery jump start	Optional
Current draw reducer unit	
Air and water system	
*Air compressor	CT28 (2.8 m ³ /min, at 7 bar)
Compressed air outlet	Quick coupling
Water hose reel and hose	THR2.5E, with Ø38 mm (1 ½"), 100 m
Operator's safety cabin	
*Low height cabin	FOPS/ROPS (ISO 3449/3471) height 2 900 mm
Tiltable cabin	15° to improve operator's comfort
Cabin heating	During tramming and drilling
Fire suppression system	
Spare hand held fire extinguisher	1 x 7.7 or 9 kg (type ABC)
Manual or automatic system	Ansul, 6 nozzles (TS2-460)
Automatic system	Sandvik Eclipse™ (TS2-461)
Carrier	
Reduced tramming speed	3 rd gear lockout
*Foam filled tires	4 pcs
Fast filling system	Complete
Rod rack	On carrier side (4 rods)
Extra items	
Spare rock drill	RD314
Spare wheel assembly	Standard or foam filled tire
Special tools for rock drill	Field kit, complete set
Spare batteries	4 x SoNick (purchased or rental)
Documentation	Extra, Catbase, Link one manuals
Warranty extension	One year (excl. Kazakhstan)
Packages: Automation	Gold or platinum level (TS2-539)
Packages: Country	USA, CAN, AUS, EU, SWE
Package: Environmental	TS2-524

*) Replaces standard feature

Technical drawings

Bolting head		Minimum operating height and width (A;D)	Optimum operating height (B)	Maximum operating height (C)	Maximum width (E)
BHi18	mm	3 150	6 600	7 585	9 970
BHi22	mm	3 650	6 600	7 585	9 970
BHi24	mm	3 900	7 060	8 045	10 890
BHi27	mm	4 110	7 060	8 045	10 890
BHi30	mm	4 450	7 060	8 045	10 890

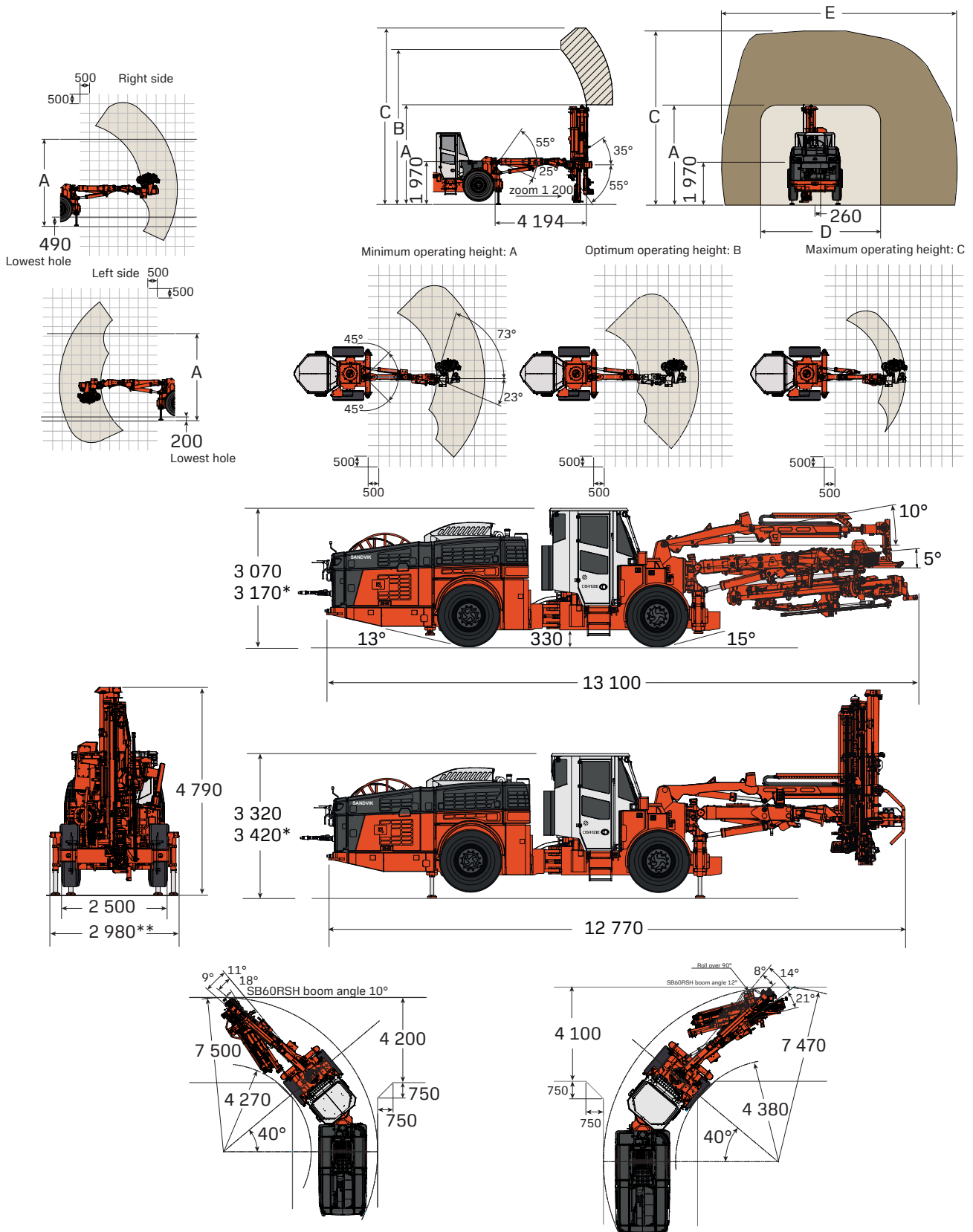

* Add 100 mm height with tilting option - ** 3 100 mm with bolts storage option
All dimensions in mm

SANDVIK

TS2-376:05ENG@Sandvik Mining and Rock Solutions 2023 SANDVIK, iSURE® and DIGITAL DRILLER™ are trademarks owned by the Sandvik group of companies.

*Test results and calculations are to be considered as results reached under certain and controlled conditions. These test results and calculations should not be treated as specifications and Sandvik does not guarantee, warrant or represent the outcome of test results or calculations in any or all circumstances.

